

High Performance BGA Cooling Solutions w/ maxiGRIP™ Attachment*

DIGI-KEY PART # **ATS1187-ND**

ATS PART # ATS-53310R-C2-R0

Features & Benefits

High aspect ratio, straight fin heat sinks that are ideal for compact PCB environments

maxiGRIP™ attachment applies steady, even pressure to the component and does not require holes in the PCB

Designed specifically for BGAs and other surface mount packages

Meets Telcordia GR-63-Core Office Vibration; ETSI 300 019 Transportation Vibration; and MIL-STD-810 Shock Testing and Unpackaged Drop Testing standards

Comes preassembled with high performance, phase changing, thermal interface material

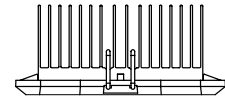
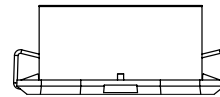
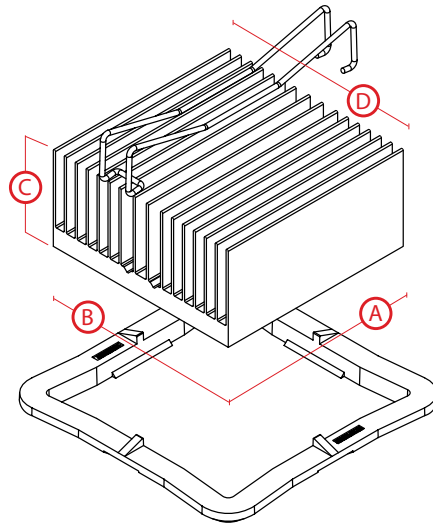

Thermal Performance Table

AIR VELOCITY		THERMAL RESISTANCE	
FT/MIN	M/S	°C/W (UNDUCTED)	°C/W (DUCTED)
200	1.0	4.7	3.1
300	1.5	3.8	
400	2.0	3.3	
500	2.5	2.9	
600	3.0	2.7	
700	3.5	2.5	
800	4.0	2.4	

Product Details†

DIMENSION A	DIMENSION B	DIMENSION C§	DIMENSION D	TIM†	FINISH
31	31	19.5	N/A	C1100F	BLACK-ANODIZED

For further technical information, please contact Advanced Thermal Solutions, Inc. at **1-781-769-2800** or www.qats.com

* RoHS Compliant

‡ TIM = Thermal Interface Material

† Dimensions are measured in millimeters

◆ Dimensions A & B refer to component size

§ Dimension C = the height of the heat sink shown above and does not include the height of the attachment method



ATS ADVANCED THERMAL SOLUTIONS, INC.

Innovations in Thermal Management®



To place an order, please visit www.digikey.com